

下面

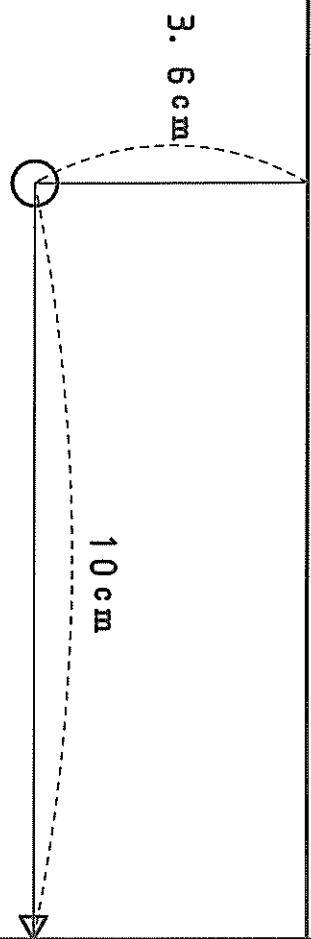

左側面

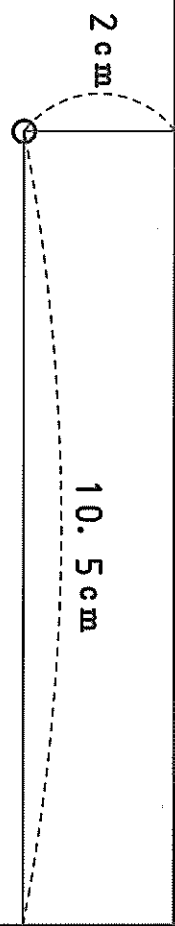

上面

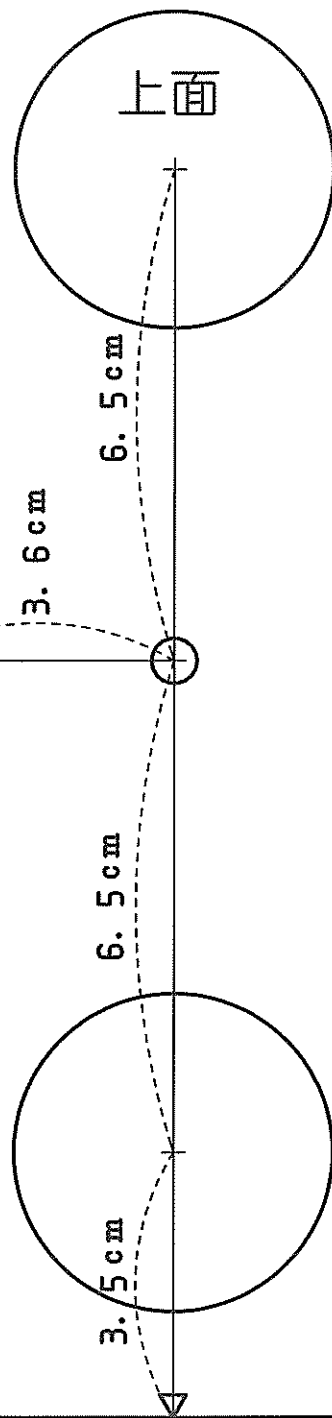

台座

右側面 (あけぐち側)

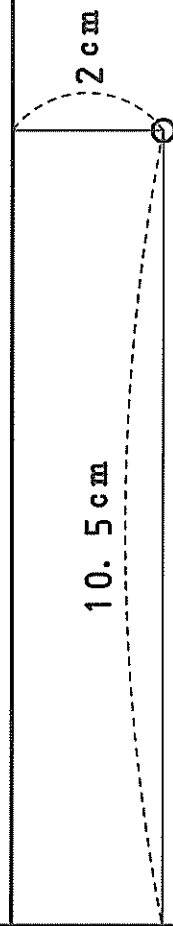

テーブル用型紙

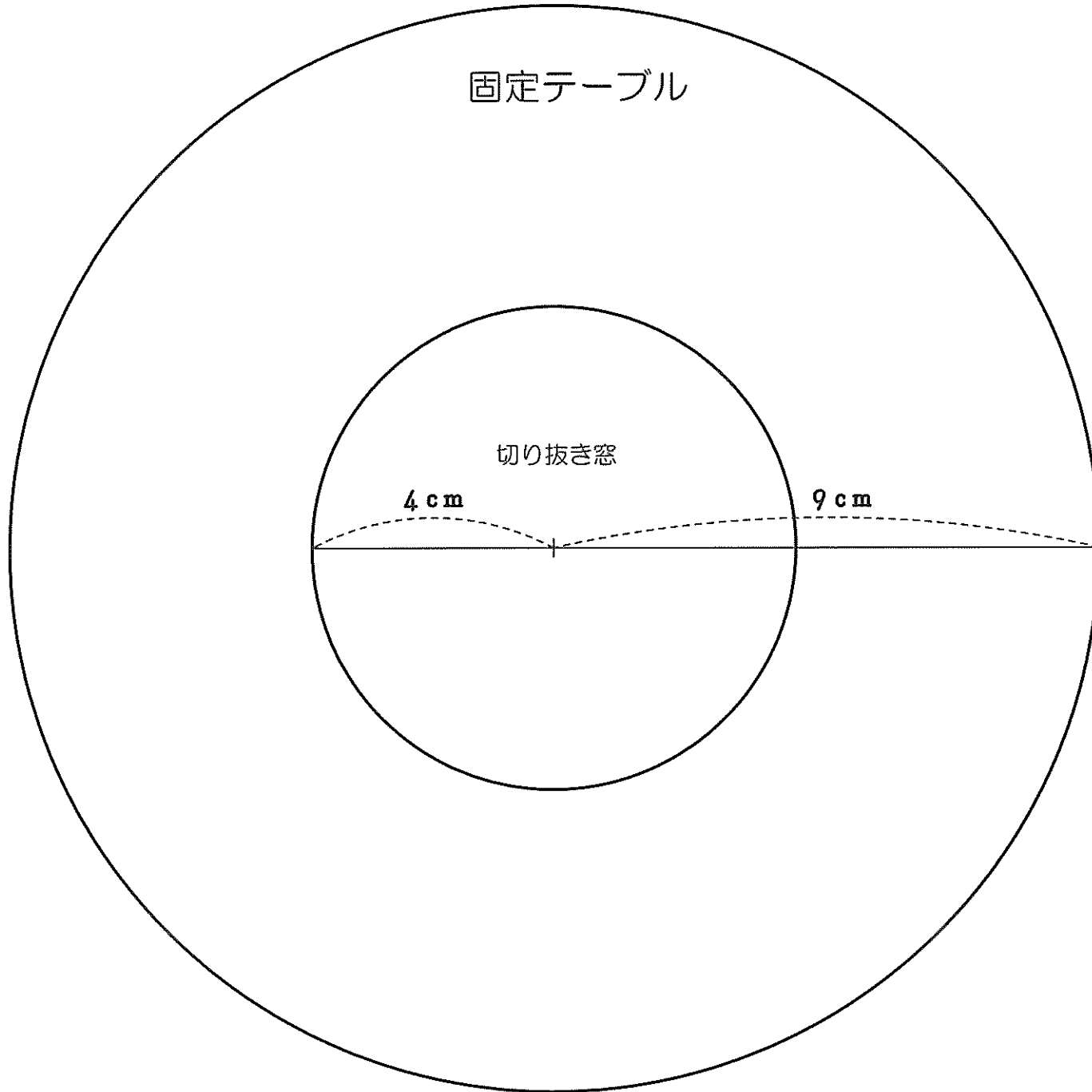

竹串、ストロー用型紙

竹串

17 cm (ハンドル、ピン歯車取付け用)



17 cm (ピン歯車、タイヤ用) 縦線の位置にしるしをつけよう

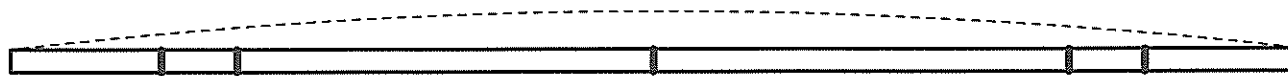

13.5 cm (台座中心ピン歯車用)



11 cm (輪ゴム取付け用)

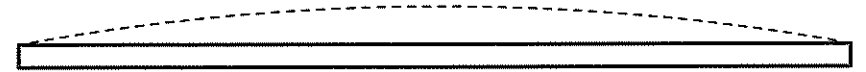

5.5 cm (回転テーブル中心用2本)

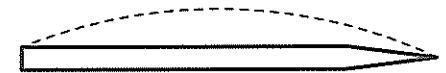

2.5 cm (ピン歯車用12本)

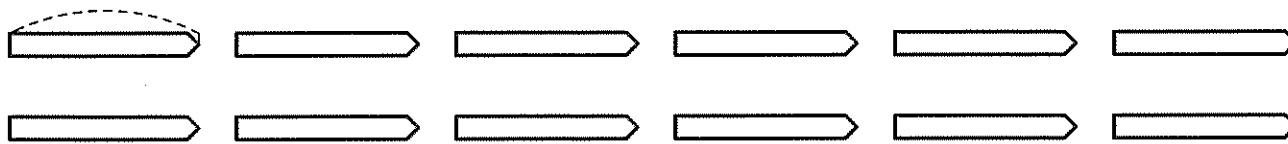

5 cm (輪ゴム巻取りハンドル用)

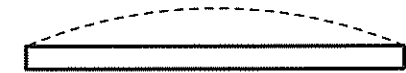

ストロー

2 cm (回転テーブルの中心に通す用2個)



1.5 cm (タイヤの抜け止め用)



2.5 cm (回転テーブル中心の竹串固定用2個)



1 cm

10 cm (台座中心の竹串を通す用)

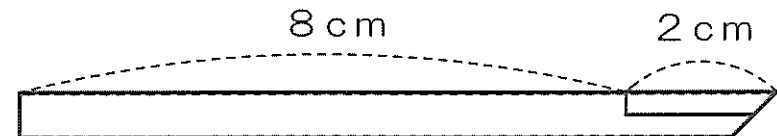

8 cm

2 cm

コーヒーカップ、キャップ用型紙

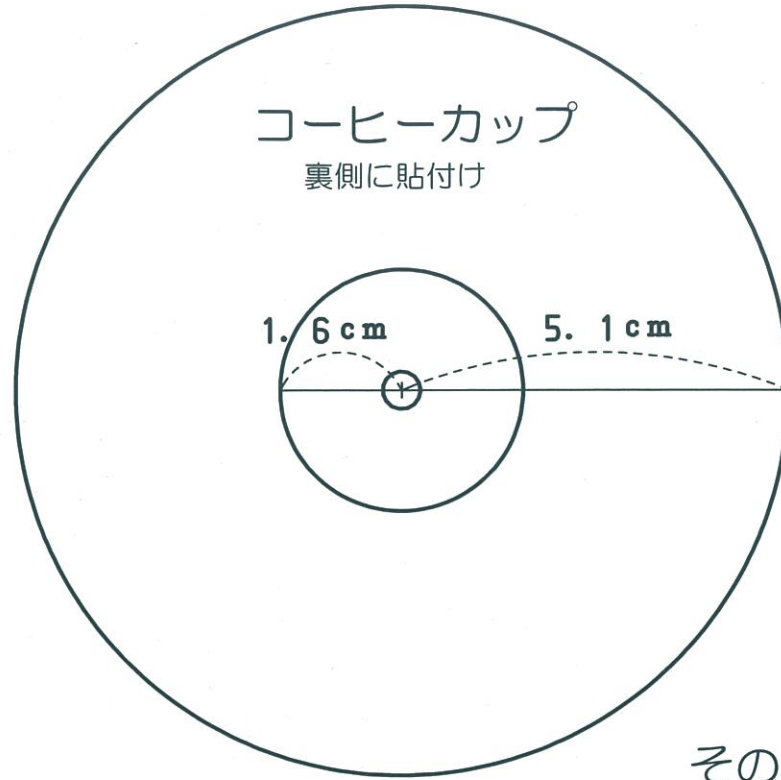
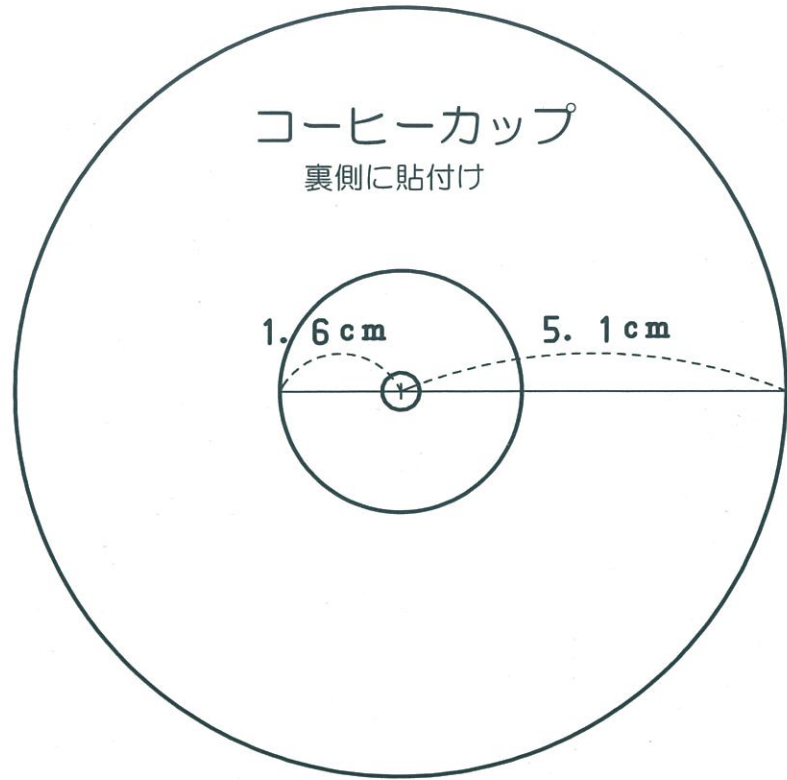

ピン歯車のキャップ

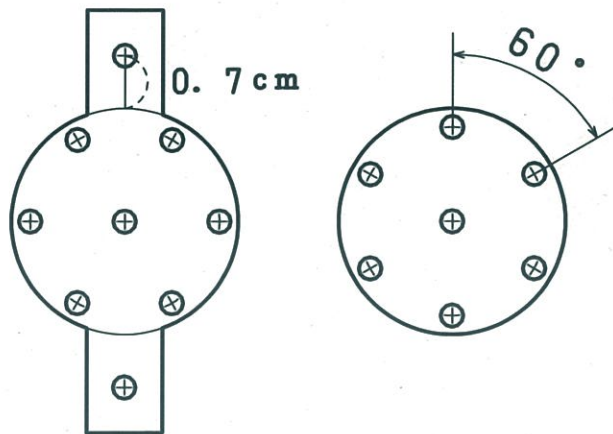

その他のキャップ 大きく穴をあけよう

